



Budapest University of Technology and Economics

Department of Mechanics, Materials and Structures
English courses
General course /2015
Fundamentals of Structures BMEEPSTG201

Lecture no. 4:

Structural modelling, the static model of load-bearing structures

Content:

Introduction

1. Components of the static model
2. Structural members
3. Joints
4. Some important static models
5. Classification of structures
6. The fundamental laws of the structural analysis

Introduction – the structural design process

The *aim of **modelling** structures* is

to simplify the ***analysis** of structures*.

The aim of structural analysis is

to determine ***responses of structures***
subjected to loads and effects.

Responses of structures are:

-deformations, deflections, sways, vibrations and corresponding
-stresses, internal forces (resultants of stresses over cross-sections of *linear, planar or spatial members*). These responses will be discussed in detail later.

The knowledge of the responses of structures when loaded is necessary for the

evaluation of the behaviour of the structure, the *rate of safety of the structure*.

If the rate of safety can not be accepted, characteristics of the structure (geometry, dimensions, mechanical characteristics, strengths of the structural materials) are to be modified to fulfil the safety requirements. The whole process described above is *structural design*.

1. Components of the static model

The static model of structures is composed of

structural members,

interconnected by

internal joints

and supported by the ambient (the earth) by means of

external joints.

Loads are applied to the static model.

2. Structural members

Geometrically, structural members can be classified as: linear, planar and spatial members.

Linear members are parts of the structure, having one important extension in the space, along their axis, at least 4 to 5 times greater than their cross-sectional dimensions, that is its extensions perpendicular to the axis-direction. In the structural model linear members are substituted by their *axis*. The axis can be straight, curved or eventually polygonal, interconnecting the centres of gravity of the cross-sections. Linear members can be – geometrically - described by their axis and cross-section(s). The cross-section can be constant or variable.

Surface members have two important extensions in their plane, compared to their third extension: their *thickness*, which is at about one order of magnitude smaller. In the structural model, surface members are substituted by their *middle-plane*, taken at half-thickness depth. The

middle-plane of surface members can be planar, simply curved (that is can out-spread in one plane), or doubly curved, that is can not out-spread in one plane. Surface members can be described – geometrically – by their middle-plane and *thickness*, that latter can be constant or variable.

Spatial members have three important extensions in the space. Some examples of straight and curved linear members (beams, arch) and surface members (slab and wall) are shown below:

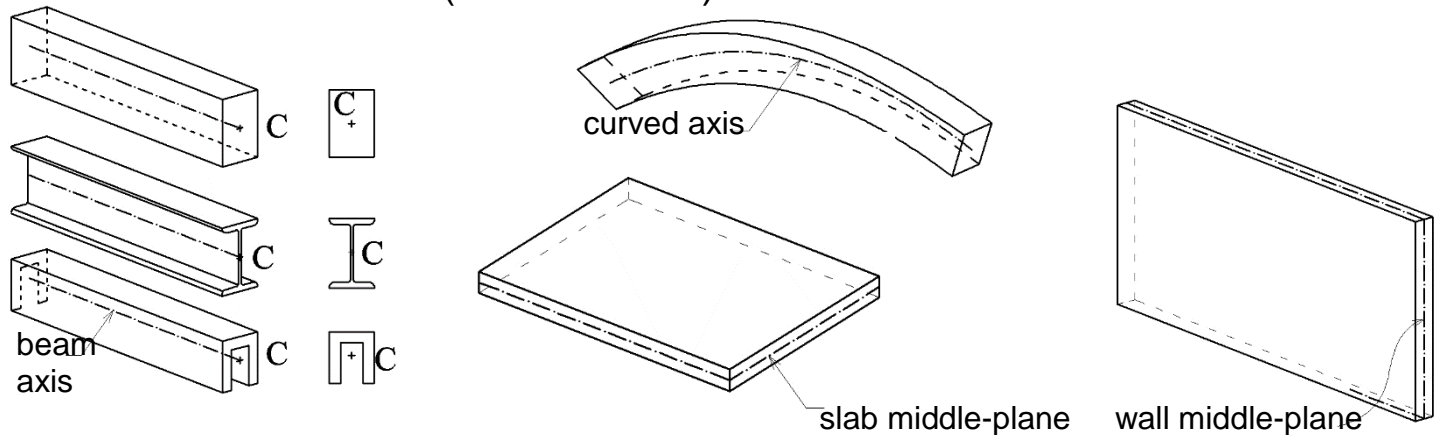

3. Joints

Typical steel column- foundation joints (external joints):

1. simple support

2. hinged support

3. restrained support

axonometric view

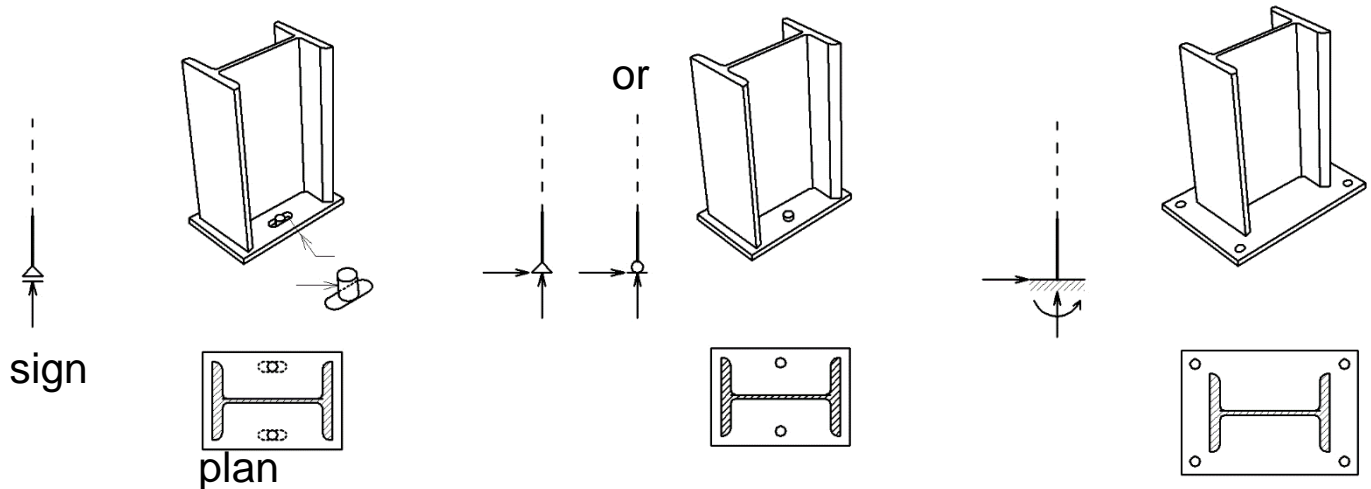

Internal joints of planar linear members

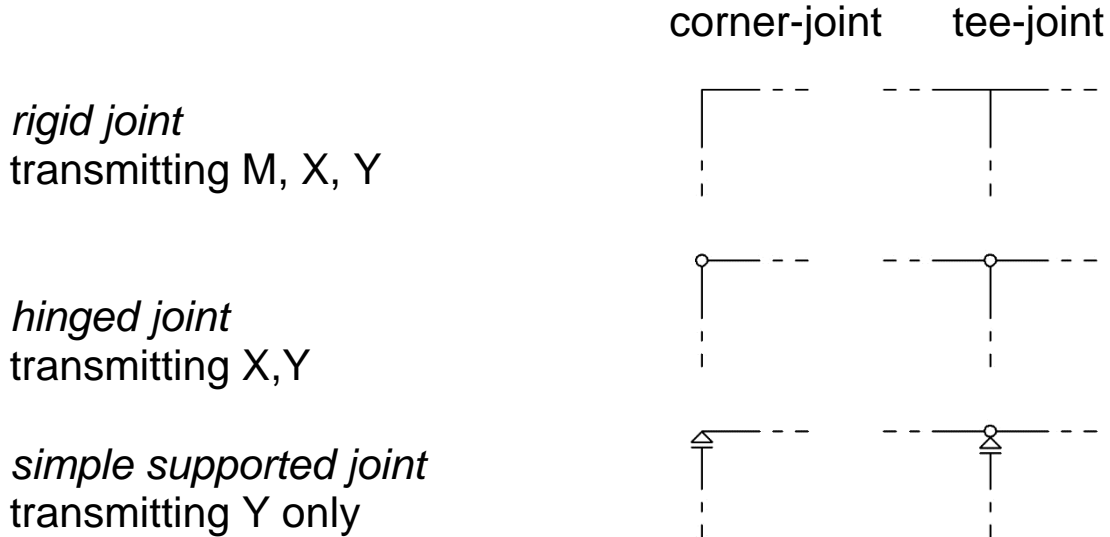

M: moment

X: horizontal force component

Y: vertical force component

4. Some important static models

Simple supported beam

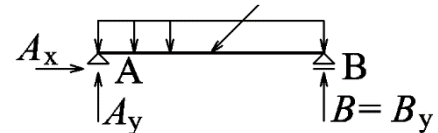
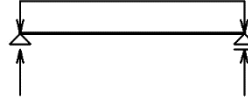

Loaded a) by uniformly distributed load b) by general loading

Cantilever

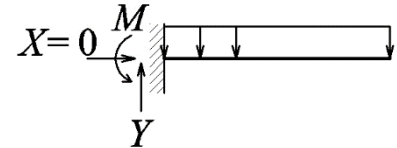
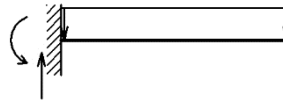
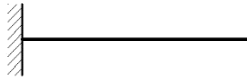

Continuous beam

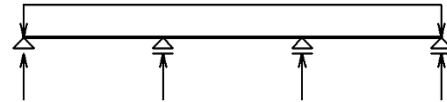

Gerber beam (statically determinate continuous beam with internal hinges)

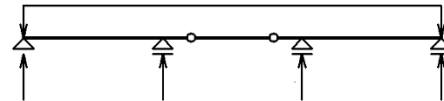

Simple supported arch

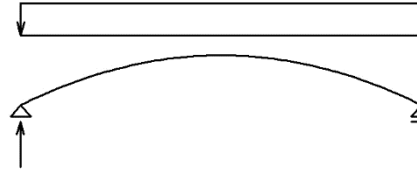

Double hinged arch

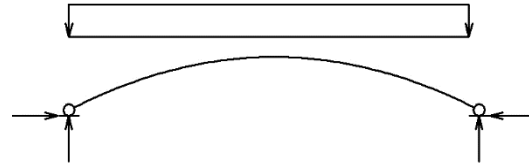

Three hinged arch

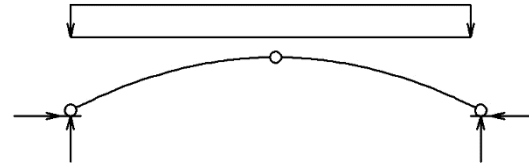
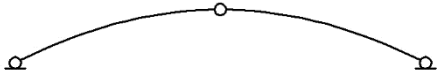

Different portal frames

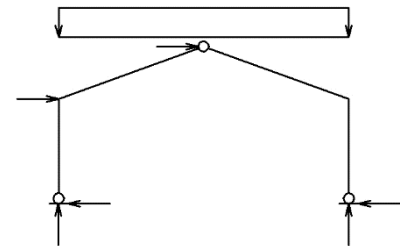
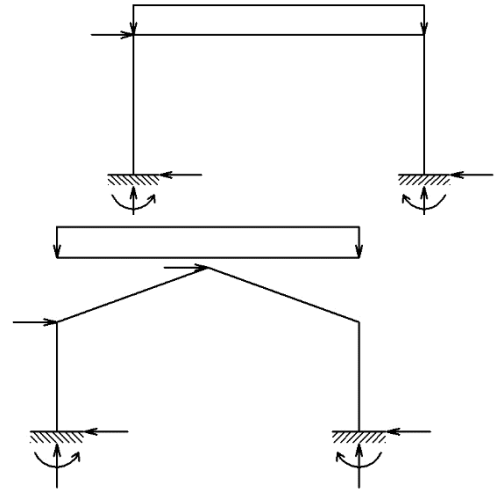
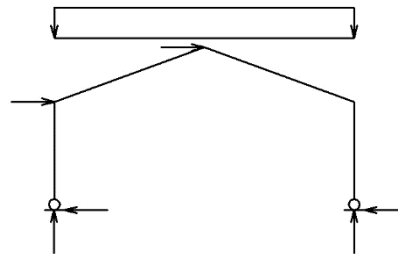
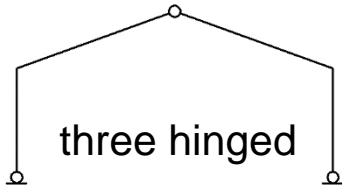
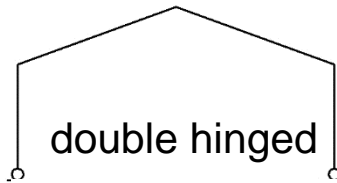
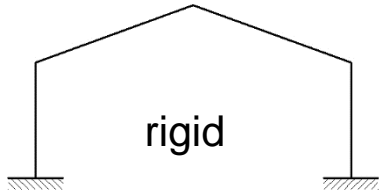

Hinged double-bay portal frame

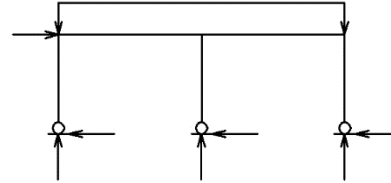
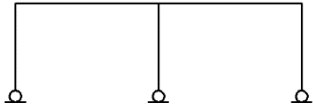

Multi-storey two-bay rigid frame

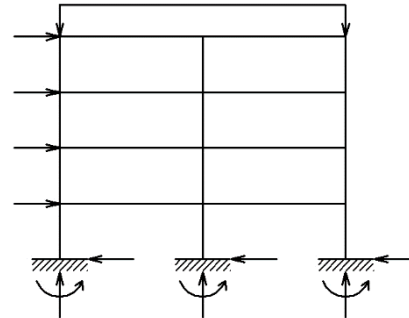
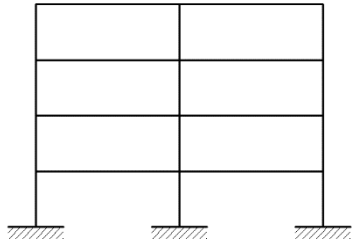

5. Classification of structures

From the point of view of:

-the *structural material*: timber, stone, ceramic, iron, steel, concrete, reinforced concrete, aluminium, plastic, composite (timber and concrete, steel and concrete etc.)

-the *geometry and load distribution*: planar, spatial

-the *number of storeys*: single storey, multi-storey, high-rise

-the *span*: normal span, high span structures (above cca. 30 m spans)

-the *internal forces*: structures without shear etc.

6. The fundamental laws of the structural analysis

1. Equilibrium: the whole structure or any separated part of the structure is in equilibrium. The equilibrium is formulated by a set of independent equilibrium conditions, for example in case of coplanar structures (members and supports of the structure and the loads acting on it are all in one plane):

$$\Sigma F_x = 0 \qquad \Sigma F_y = 0 \qquad \Sigma M_i = 0$$

where: F : force, M : moment, i : any point lying in the plane of the structure, x and y : axis of an orthogonal coordinate system lying in the same plane

2. Material law: mathematical description of the mechanical behaviour of the structural material(s)

For example: stress (σ) – strain (ε) relationships describing the behaviour of the structural material under uniaxial, instantaneous loading.

Examples for concrete and reinforcing steel:

Concrete:

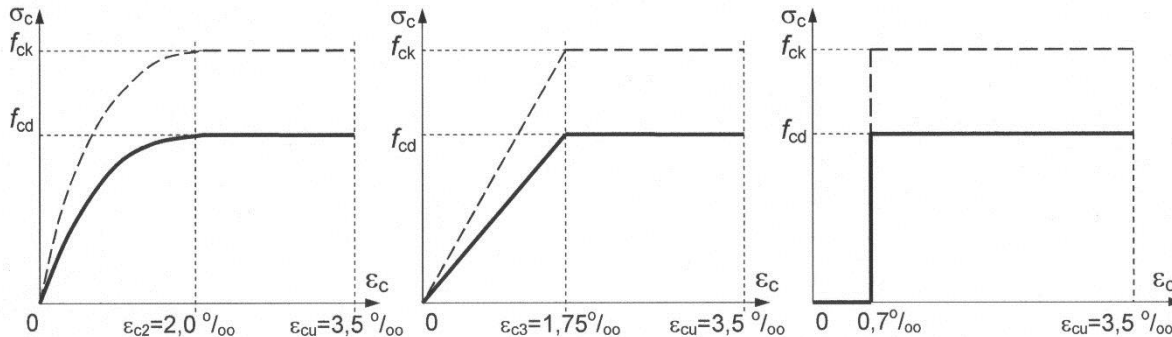

a) nonlinear elastic-plastic b) bilinear

FUNDAMENTALS OF STRUCTURES 2015

c) rigid- perfectly plastic

4. STRUCTURAL MODELLING page 17

Reinforcing steel:

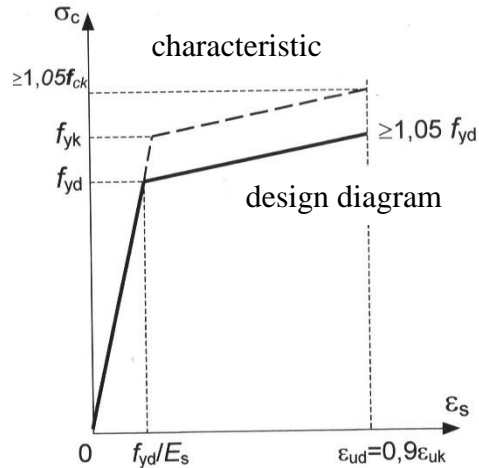

a) bilinear

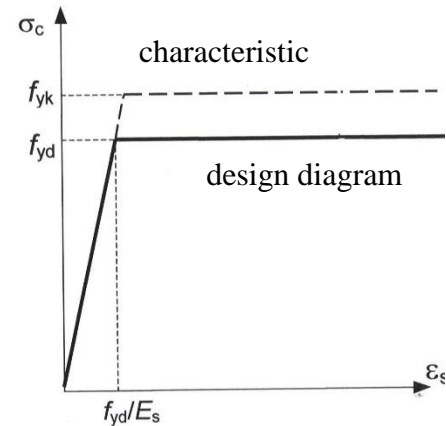

b) linear elastic- perfectly
plastic

3. Continuity of the structure: mathematical formulation of the fact, that parts (points or cross-sections) of the structure joining to each other before deformations remain together after the deformations take place by the effect of loads.

For example, let us consider a multi-storey plane frame given on the figure below:

Consider the joint „k,, and two linear members „i,, and „j,, joining to joint „k,,! By the effect of the applied loads joint „k,, is moving by the displacement components (u_k, v_k, φ_k). Some of the conditions expressing continuity of the structure referring to joint „k,, are:

$$U_{j,\text{left}} = U_{i,\text{top}} = U_k$$

$$V_{j,\text{left}} = V_{i,\text{top}} = V_k$$

$$\varphi_{j,\text{left}} = \varphi_{i,\text{top}} = \varphi_k$$

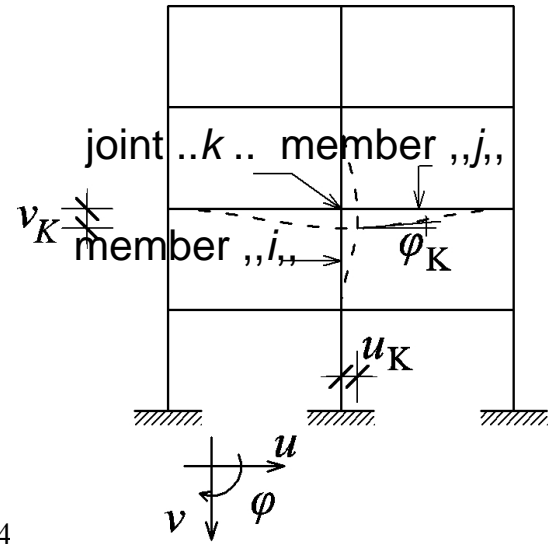

The displacement components (u_k, v_k, φ_k) are *unknowns* of the method of analysis of the structure (for example the finite element method) figuring in equations which express the equilibrium of the joints of the structure.