

**Belsőerő ábrák:**

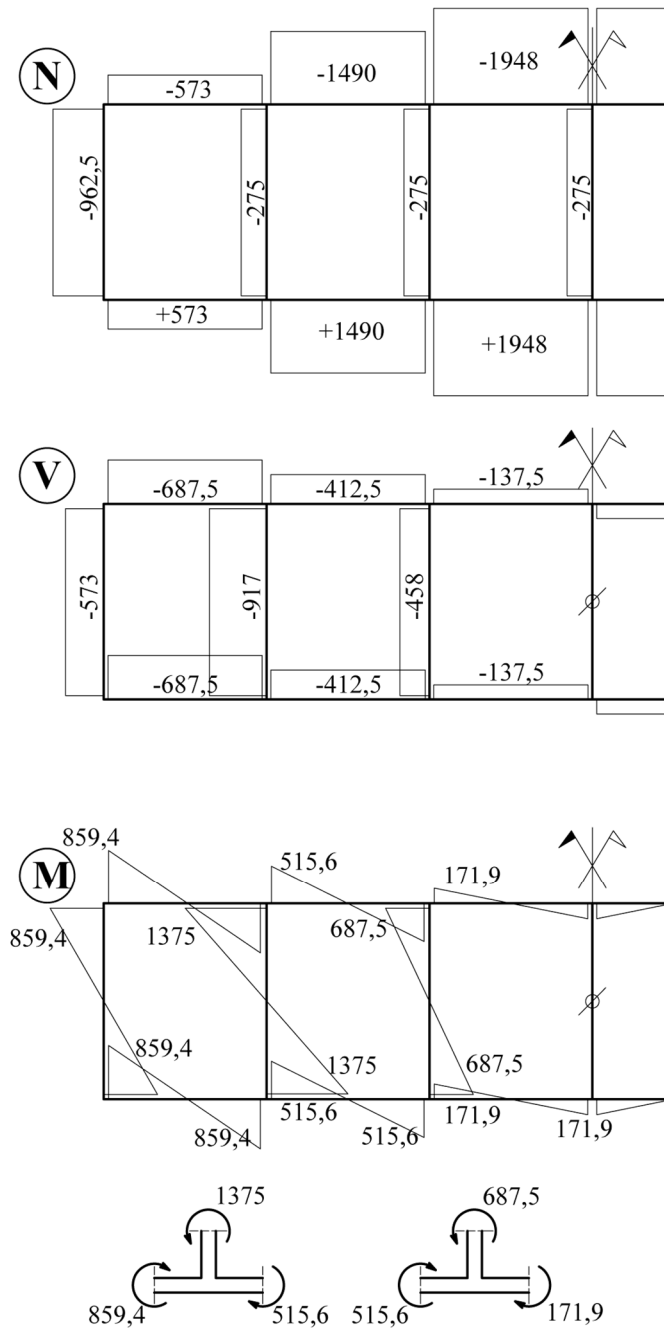
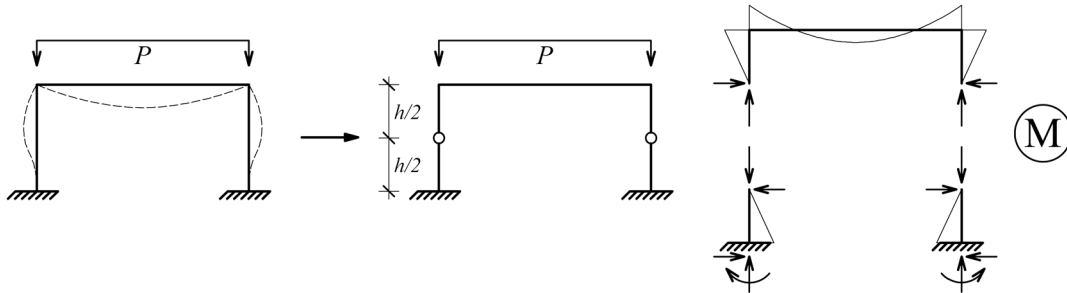
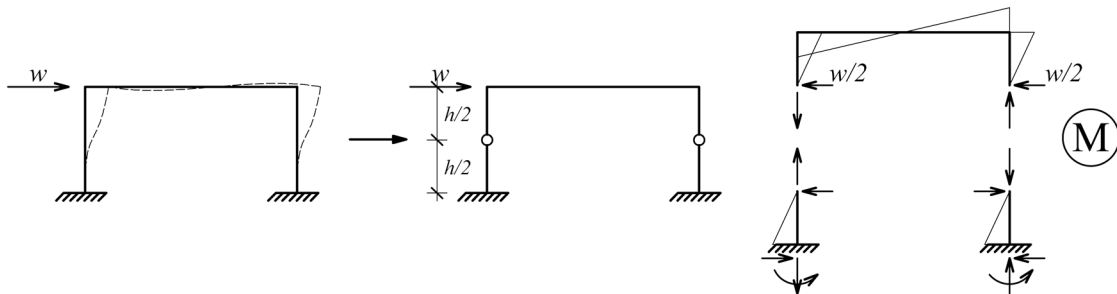

## T2/2 – Keretszerkezet vizsgálata

Függőleges teher:Vízszintes teher:

Függőleges terhek

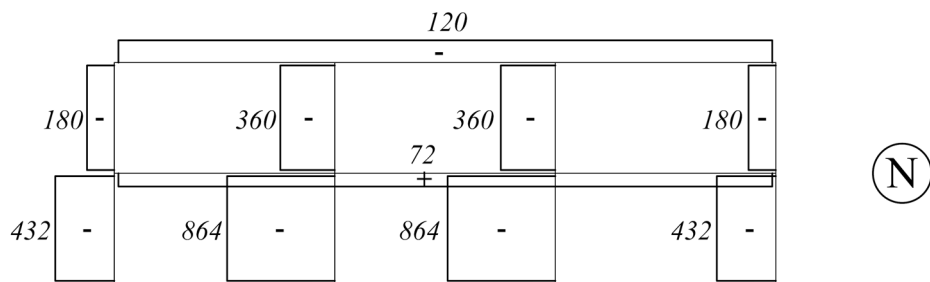
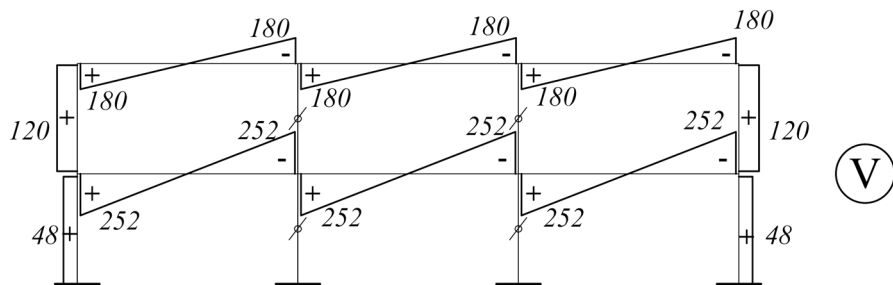
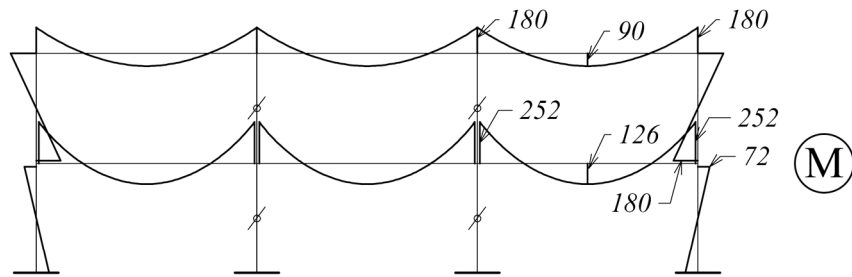
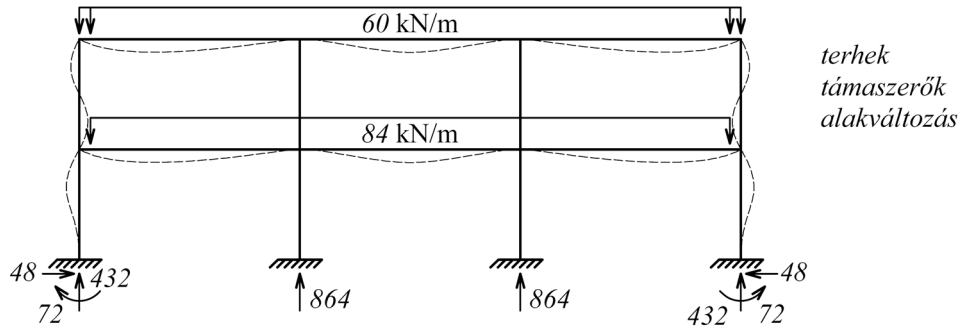

T2 VIERENDEEL TARTÓ ÉS KERETSZERKEZET - BELSŐERŐ ÁBRÁK

Vízszintes terhek

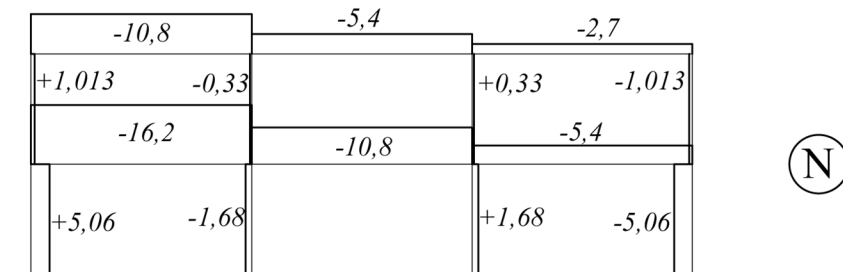
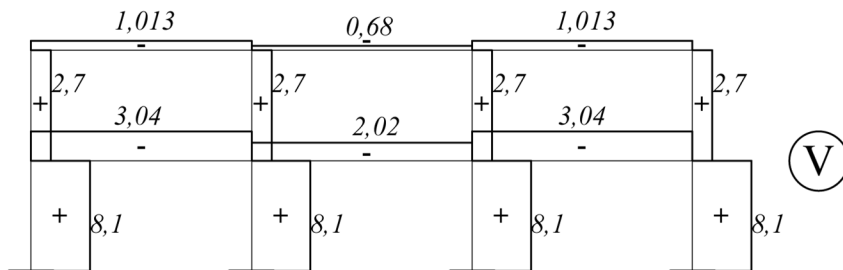
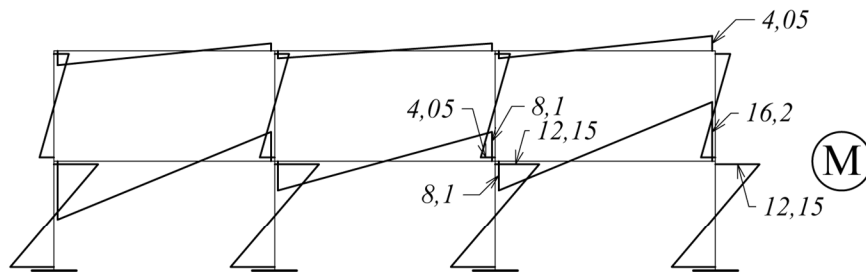
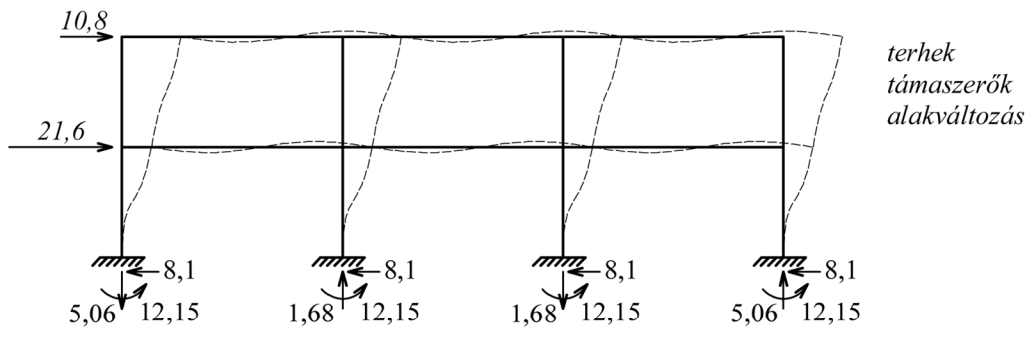

T2 VIERENDEEL TARTÓ ÉS KERETSZERKEZET - BELSŐERŐ ÁBRÁK

Függőleges és vízszintes terhek együttes hatása

